



BECM-D Ultima Series 50Hz Mini Cassette VRF Indoor Unit Installation Manual

ENGLISH

- ✓ Read this Manual before the operation and keep it for reference.
- ✓ Read all safety precautions on the manual, improper use can cause serious injury.

Specification and performance data listed herein are subject to change without notice

www.omegainverter.com



Is a product of  Environmental Technologies LLC.

Contents



Installation Manual.....	1
Accessories.....	3
1. Before Installation.....	4
2. Choosing an Installation Site.....	4
3. Indoor Unit Installation.....	4
4. Refrigerant Piping Installation	8
5. Water Discharge Piping Installation	9
6 Electrical Wiring.....	9
7. On-site Configuration	11
8. Test Run.....	13
9. Part Names	14
10. The Explain Of The Display Panel	15
11. Air Conditioner Operations and Performance	15
12. Adjusting Air Flow Direction	16
13. Maintenance.....	16
14. Symptoms That Are Not Faults	17
15. Troubleshooting.....	18

Installation Manual

Safety Precautions

Read carefully before you install the air conditioner to make sure that the installation is correct.

There are two types of precautions as described below:

-  **Warning:** Failure to comply may lead to death or serious injury.
-  **Caution:** Failure to comply may lead to injury or damage of the unit. Depending on the situation, this may also lead to serious injury. Once the installation is completed, and the unit has been tested and verified to be operating normally, please explain to the customer how to use and maintain the unit according to this manual. In addition, make sure that the manual is kept properly for future reference.

Warning

- Installation, maintenance and cleaning the filter work must be carried out by professional installers. Refrain from doing it yourself. Improper installation may cause water leakage, electric shock, or fire.
- Install the air conditioner according to the steps described in this manual. Improper installation may cause water leakage, electric shock, or fire.
- For installation in smaller rooms, you must adopt the relevant measures to prevent the refrigerant concentration from exceeding the limit. Please consult the sales agent on the relevant measures required. A high concentration of refrigerant in an airtight space can cause oxygen insufficiency (anoxia).
- Make sure the required parts and accessories are installed. Using unspecified parts may cause the air conditioner to malfunction or drop, as well as water leakage, electric shock, and fire.
- Mount the air conditioner in a place that is sturdy enough to bear its weight. If the base is not secured properly, the air conditioner may drop leading to damages and injuries.
- Take in full consideration to the effects of strong winds, typhoons and earthquakes, and reinforce the installation. Improper installation may cause the air conditioner to drop leading to accidents.
- Make sure a standalone circuit is used for the power supply. All electrical parts must comply with the local laws and regulations, and what is stated in this installation manual. The installation works must be carried out by a professional and qualified electrician. Insufficient capacity or improper electrical works can lead to electric shock or fire.







- Use only electrical cables that fulfil the specifications. All wiring on site must be carried out in accordance with the connection diagram attached to the product. Make sure that there are no external forces acting on the terminals and wires. Improper wiring and installation may cause a fire.
- Make sure the power cord, communication and controller wiring are straight and level when you are working on the connections, and the cover on the electric box is tight. If the electric box is not closed properly, it may lead to electric shock, fire or overheating of electrical components.
- If the refrigerant leaks during installation, open the doors and windows immediately to ventilate the area. Refrigerant can produce toxic gases when in contact with fire.
- Switch off the power supply before touching any electrical component.
- To prevent electrical shock, do not touch a switch with wet hands.
- Do not come in direct contact with the refrigerant leaking from the connections of refrigerant piping. Otherwise, it may lead to frostbite.
- The air conditioner must be grounded. Do not connect the earth line (ground) to gas piping, water piping, lightning rods or telephone earth lines. Improper grounding can lead to electric shock or fire, and may cause mechanical failure due to current surges from lightning and so on.
- The earth leakage circuit breaker must be installed. There is a risk of electric shock or fire if the earth leakage circuit breaker is not installed.
- The appliance shall be installed in accordance with national wiring regulations.
- The appliance must be installed 2,3m above floor.
- If the supply cord is damaged, it must be replaced by the manufacturer or its service agent or a similarly qualified person in order to avoid a hazard.
- An all-pole disconnection switch having a contact separation of at least 3mm in all poles should be connected in fixed wiring.
- The temperature of refrigerant circuit will be high, please keep the interconnection cable away from the copper tube.
- The power cord type designation is H05RN-For above/H07RN-F.
- Check the power supply before installation. Ensure that the power supply must be reliably grounded following local, state and National Electrical Codes. If not, for example, if the ground wire is detected charged, installation is prohibited before it is rectified. Otherwise, there is a risk of fire and electric shock, causing physical injury or death.
- Check the electric wire, water and gas pipeline layout inside the wall, floor and ceiling before installation. Do not implement drilling unless confirm safety with the user, especially for the hidden power wire. An electroprobe can be used to test whether a wire is passing by at the drilling location, to prevent physical injury or death caused by insulation broken cords.

 Caution

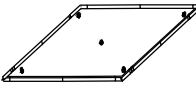



- Install the water discharge piping according to the steps described in this manual, and make sure that the water discharge is smooth, and the piping is properly insulated to prevent condensation. Improper installation of the water discharge piping may lead to water leakage, and damage the indoor furniture.
- When mounting the indoor and outdoor units, make sure the power cord is installed at a distance of at least 1 m away from any TV or radio so as to prevent noise or interference with the images.
- The refrigerant required for the installation is R410A. Make sure the refrigerant is correct before installation. Incorrect refrigerant may cause the unit to malfunction.
- Do not install the air conditioner in the following places:
 - 1) Where there is oil or gas, such as the kitchen. Otherwise, the plastic parts may age, fall off or water may leak.
 - 2) Where there are corrosive gases (such as sulphur dioxide). Corrosion in the copper pipes or welded parts may cause the refrigerant to leak.
 - 3) Where there are machines emitting electromagnetic waves. Electromagnetic waves may interfere with the control system, causing the unit to malfunction.
 - 4) Where there is a high salt content in the air. When exposed to air with a high salt content, the mechanical parts will experience accelerated ageing which will severely compromise the service life of the unit.
 - 5) Where there are major voltage fluctuations. Operating the unit using a power supply system that has large voltage fluctuations will reduce the service life of the electronic components, and cause the unit's controller system to malfunction.
 - 6) Where there is a risk of leakage of flammable gases. Examples are sites that contain carbon fibres or combustible dust in the air, or where there are volatile combustibles (such as diluent or petrol). The above gases may cause explosion and fire.
 - 7) Do not touch the fins of the heat exchanger as this may lead to injury.
 - 8) Some products use the PP packing belt. Do not pull or tug on the PP packing belt when you transport the product. It will be dangerous if the packing belt breaks.
 - 9) Note the recycling requirements for nails, wood, carton and other packaging materials. Do not discard these materials directly as these may lead to bodily harm.
 - 10) Tear up the packaging bag for recycling to prevent children from playing with it, and leading to suffocation.
 - 11) The appliance shall not be installed in the laundry.
- When the product is used for commercial application. This appliance is intended to be used by expert or trained users in shops, in light industry and on farms, or for commercial use by lay persons, the sound pressure level is below 70 dB(A).

Accessories

Verify that the air conditioner includes the following accessories.

	Name	Appearance	Qty
1	Installation Manual		1
2	Installation board		1
3	Insulation casing for copper pipe		2
4	Insulation casing for water discharge piping		1
5	Ring clamp for water discharge pipe		1
6	Tie for water discharge piping		6
7	Soft flexible hose for water discharge		1
8	Brass nut		2

Accessories to purchase locally

Code	Name	Appearance	Dimensions	Qty	Note
1	Copper pipe		Choose and purchase copper pipes that correspond to the length and size calculated for the selected model in the installation manual of the outdoor unit and your actual project requirements.	To purchase based on actual project requirements.	Used to connect indoor refrigerant piping.
2	PVC pipe for water discharge		Outer diameter: 37-39 mm, inner diameter: 32 mm	To purchase based on actual project requirements.	Used to discharge condensed water from the indoor unit.
3	Insulation casing for piping		The inner diameter is based on the diameter of the copper and PVC pipes. The thickness of the pipe casing is 10 mm or more. Increase the thickness of the casing (20 mm or thicker) when the temperature exceeds 30°C or the humidity exceeds RH80%.	To purchase based on actual project requirements.	Protect piping from condensation.
4	Expansion hook anchor		M10	4	For installation of indoor unit
5	Mounting hooks		M10	4	For installation of indoor unit

1. Before Installation

1. Determine the route to move the unit to the installation site.
2. First unseal and unpack the unit. Then, hold the seats of the hanger (4 pcs) to move the unit. Refrain from exerting force on other parts of the unit, especially the refrigerant piping, water discharge piping, and the plastic parts.

2. Choosing an Installation Site

1. Choose a site that fully complies with the following conditions and user requirements to install the air conditioning unit.
 - Well ventilated.
 - Unobstructed airflow.
 - Strong enough to bear the weight of the indoor unit.
 - Ceiling has no obvious slant.
 - There is sufficient space for repair and maintenance work to be carried out.
 - No leakage of flammable gas.
 - The length of the piping between the indoor and outdoor units is within the permitted range (refer to the manual on installation of the outdoor unit).
2. Mounting height
 - Mounting height is 2.3 ~ 3.5 metres.
3. Mount using the mounting screws.
4. Space required for installation (unit (mm)):

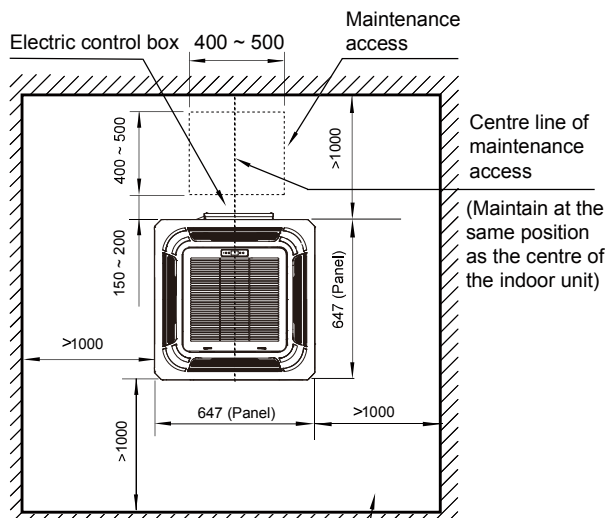

Figure 2.1

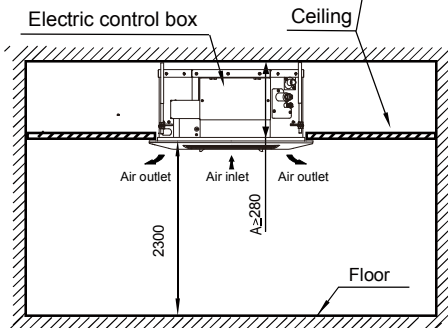

Figure 2.2

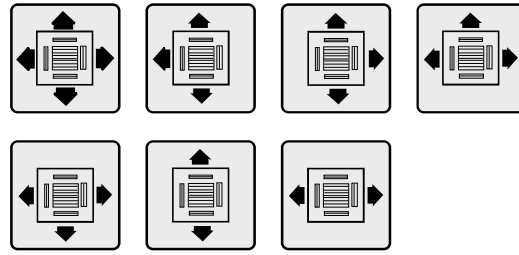

Figure 2.3

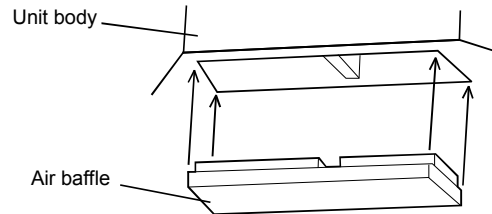

Figure 2.4

⚠ Caution

- The air baffle is not included. Please contact the sales agent to purchase the wind deflector.
- The air baffle must be installed in front of the installation panel. If the panel is already installed, make sure you remove the panel before you install the air baffle.

3. Indoor Unit Installation

Make sure that only specified components are used for the installation works.

3.1 Installation with lifting bolts

Use different bolts for the installation depending on the installation environment.

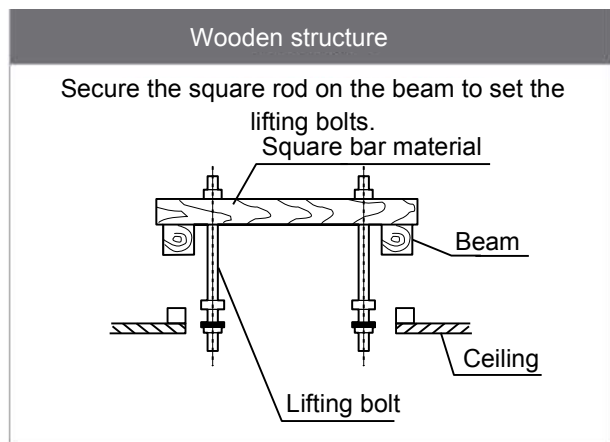

Figure 3.1

5. Based on the shape of the room, determine the airflow directions for the installation site. See Figure 2.3 for the schematic on the direction of airflow. If part of the air vent must be blocked, you may insert an air baffle at the vent of the unit body to block the air flow. See Figure 2.4.

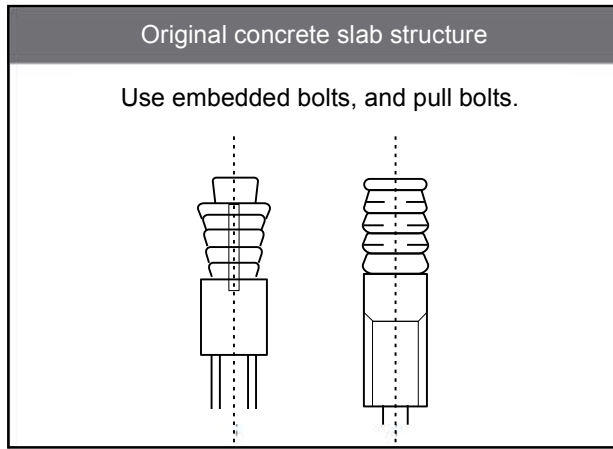

Figure 3.2

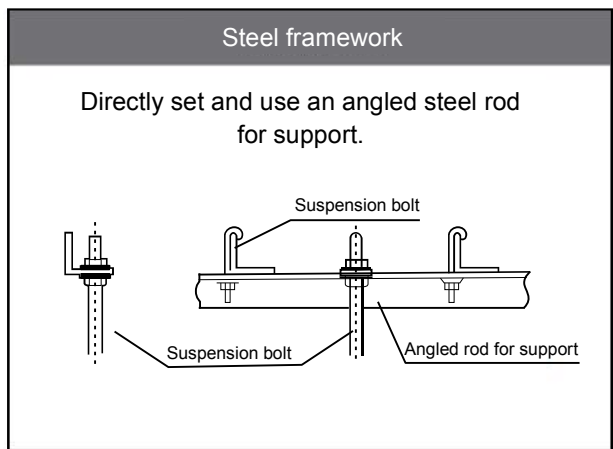

Figure 3.3

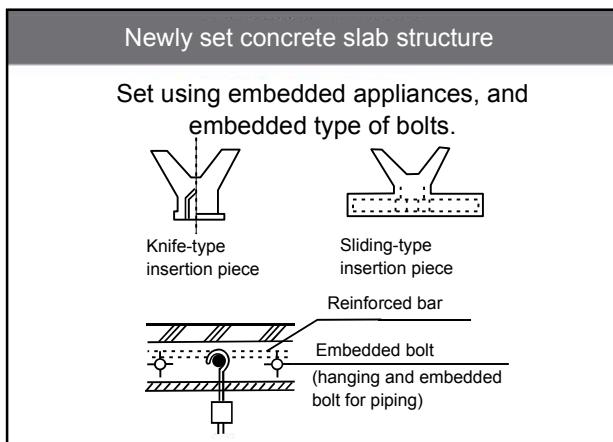

Figure 3.4

⚠ Caution

- All bolts should be made from high quality carbon steel (with galvanized surface or other rust prevention treatment) or stainless steel.
- How the ceiling should be handled will differ with the type of building. For specific measures, please consult the building and renovation engineers.
- How the lifting bolt should be secured depends on the specific situation, and it must be secure and reliable.

3.2. Indoor Unit Installation

3.2.1 Installation sequence for existing ceiling:

- Must maintain the ceiling at a level position.

1. Drill 640 mm x 640 mm square holes into the ceiling based on the layout of the installation board (accessory 2). See Figure 3.5. See Figure 2.1 for maintenance access.
 - The centre of the ceiling opening should match the centre of the body of the indoor unit.
 - Determine the length and outlets of the connecting pipes, water discharge piping and the electrical wiring.
 - In order to keep the ceiling level and prevent vibrations, reinforce the strength of the ceiling when necessary.

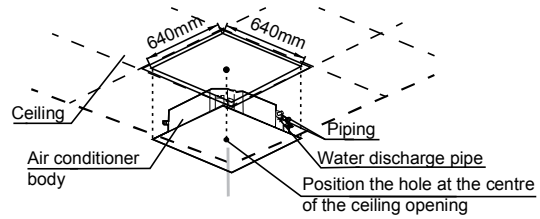

Figure 3.5

2. Install the hooks in four corners based on the layout for the hooks outlined in the installation board (accessory 2).
 - Determine the location on the ceiling of the room or building roof for mounting, and drill four $\Phi 12$ mm X 50-55 mm holes. Then embed and set up the expansion hook anchors (purchased accessory 2) in these holes. See Figure 3.2.
 - During the installation of the hooks (purchased accessory 5), make sure that the concave portion of the hanger corresponds to that of the expansion hook anchors. Determine the appropriate hook length for installation based on the ceiling's height. Remove any excess.
 - Use M10 or W3/8" bolts for the screws of the mounting hooks. Take approximately 1/2 of the screw length for the installed hooks as the excess length.

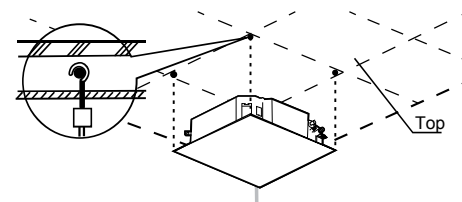

Figure 3.6

3. Use the hex nuts on the four mounting hooks to adjust and make sure that the unit body is level.
 - If the water discharge pipe is slanted, it may cause the water level switch to malfunction, and water may leak.
 - Adjust the position of the unit body, and make sure that the gap with the ceiling is evenly spaced on all four sides of the ceiling, and the base of the unit body is 10-12 mm into the base of the ceiling.
 - Once the position of the unit body is adjusted, use the nuts on the mounting hooks to secure the unit.

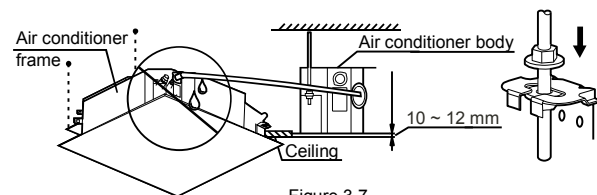

Figure 3.7

3.2.2 Installation sequence for new ceiling:

1. Refer to Step 2 of the "Installation sequence for existing ceiling". Pre-bury the hooks in the new ceiling, and make sure that they are strong enough to bear the weight of the indoor unit, and that the unit will not become loose when the concrete shrinks.
2. Once you have lifted and mounted the unit, use M5x20 screws (included with the installation board) to secure the installation board (accessory 2) on the unit body. Make sure you verify the size and positions of the opening in the ceiling and maintenance access before you do so. See Figure 3.8.
 - Before you mount the unit onto the ceiling, make sure the ceiling is level.
 - The rest of the procedures are the same as Step 2 of the "Installation sequence for existing ceiling".
3. Refer to Step 3 of the "Installation sequence for existing ceiling".
4. Remove the installation board (accessory 2).

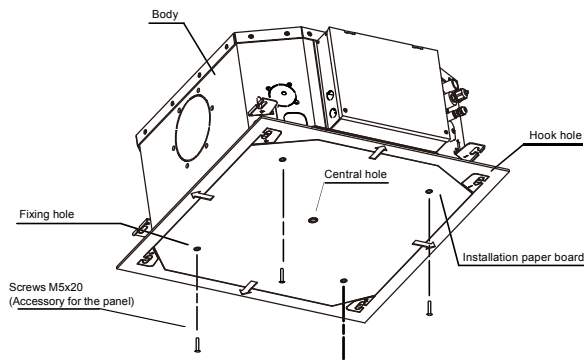

Figure 3.8

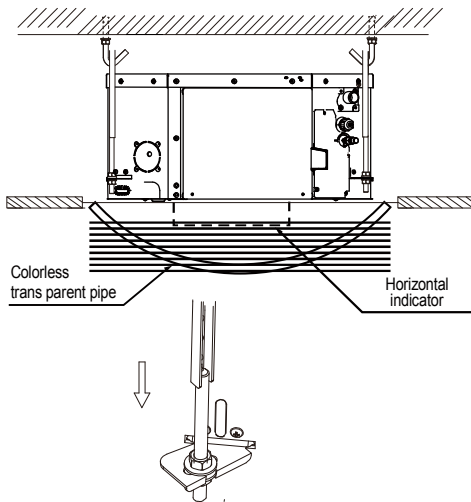

Figure 3.9

⚠ Caution

- Use adjustable mounting hooks to make sure that the unit body is level, otherwise it may cause water to leak. Calibrate the levelness of the unit using a spirit level or polyethylene tube filled with water. See Figure 3.9.
- The unit is equipped with a built-in water discharge pump and float switch. Do not tilt the unit in the direction of the drain pan; otherwise, the float switch may malfunction and cause water leakages.

Dimensions of unit

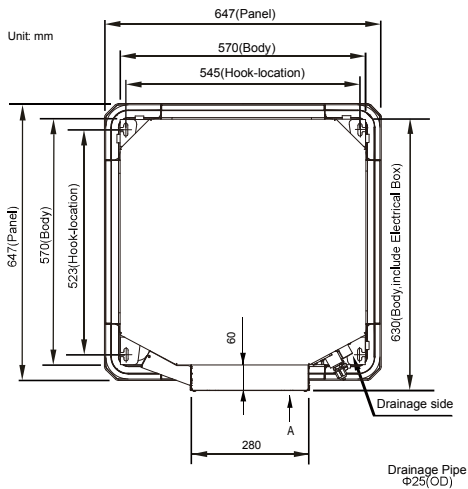

Figure 3.10

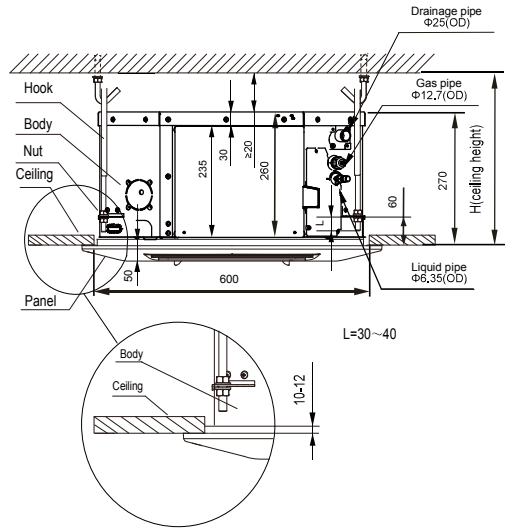

Figure 3.11

⚠ Caution

- All the figures in this manual are for illustration purposes only. The actual air conditioner you purchased may not have the same appearance and functions as those listed in these figures. Please refer to the actual product model.

3.3 Panel Installation

3.3.1 Remove the air inlet grille

- Press the two grille locks inwards in the direction indicated by the arrows at the same time to lift it up (Figure 3.12).

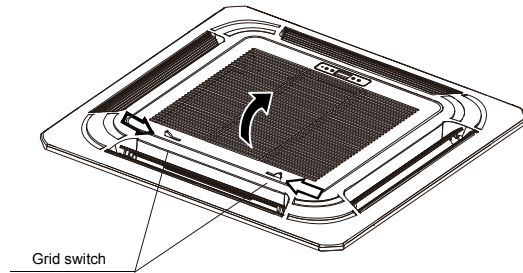

Figure 3.12

- Raise the air inlet grille to about 45°, and remove the grille.

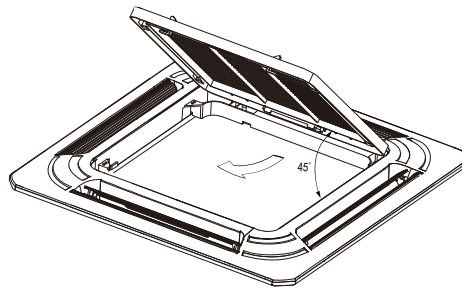

Figure 3.13

⚠ Caution

- Do not place the panel such that it faces downwards or leans against the wall. Do not place it on a protruding object either.
- Do not hit or squeeze the air deflector.

3.3.2 Panel installation

- (1) Align the panel with the unit body in the direction indicated by the arrow (see Figure 3.14).
- (2) When mounting, secure the two fixed steel ropes on the unit body to the hooks on the installation cover of the swing motor on the panel (see Figure 3.14, ① and ②).
- (3) Connect the leads from the swing motor, and display box from the panel to the corresponding connections on the unit body respectively. Take care to use protective casing to wrap the connection terminals, and use a reliable fixture to secure and strengthen the safety isolation of the terminals.
- (4) Install and secure the panel on the unit body with bolts (M5X20) and washers (see Figure 3.14, ④). Note that the installation cover of swing motor must sink into the corresponding drain pan.
- (5) Adjust the four panel hook screws to keep the panel level, and lift it evenly up to the ceiling.
- (6) Adjust the panel slightly in the direction indicated by the arrow (see Figure 3.14, ③), so that the centre of the panel aligns with the centre of the opening of the ceiling. Verify that the hooks in all four corners are securely in place.

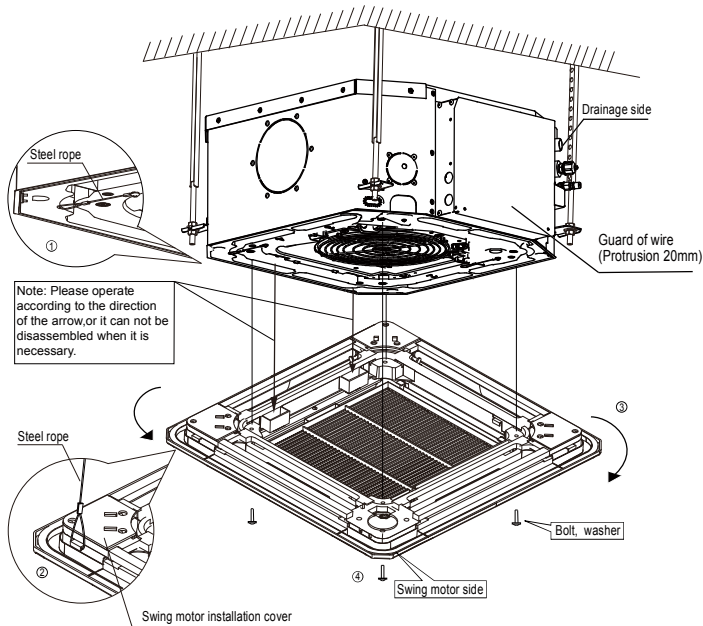

Figure 3.14

- (6) Continue to evenly tighten the screws under the hooks of the panel until the foam thickness between the unit body and the air outlet on the panel is reduced to about 4-6 mm, and there is good contact between the panel and ceiling surface.

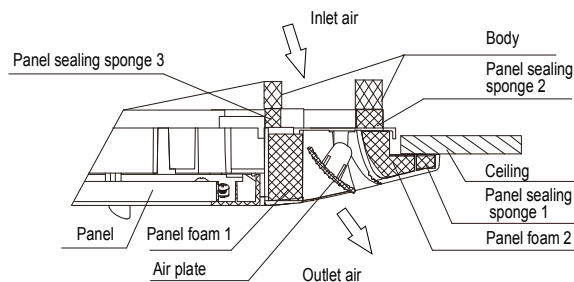
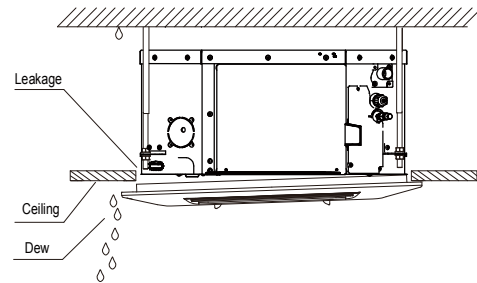

Figure 3.15

⚠ Caution

- The plastic cover plate protruding from the swing motor must be embedded within the concave area of the sealing plate.
- Make sure the wiring of the swing motor is not caught inside the sealed foam.
- Air and water leakages may result if the screws are too loose. See Figure 3.16.
- No gap is allowed between the ceiling and the panel. See Figure 3.17.
- If it does not affect the lifting and lowering of the indoor unit and the water discharge piping, you can use the openings at the four corners of the panel to adjust the height of the indoor unit. See Figure 3.18.



Droplets of condensed water, dripping water.

Figure 3.16

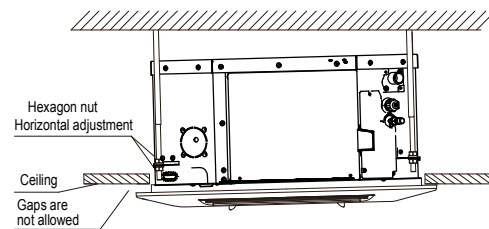

Figure 3.17

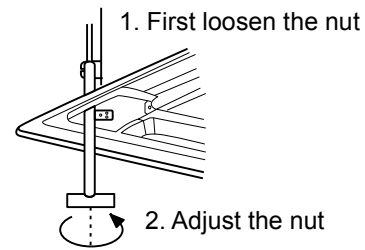

Figure 3.18

3.3.3 First hang the air inlet grille on the panel, and then connect the leads of the swing motor and display box to the corresponding connections on the unit body respectively. Use the protective casing (accessories 3, 4) to enclose the connecting terminals, and use tie straps (accessory 5) to fasten securely to strengthen the safety isolation at the terminals. See figures 3.19-3.21.

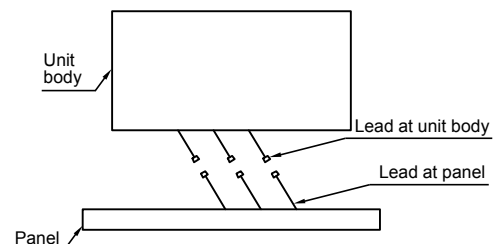

Figure 3.19

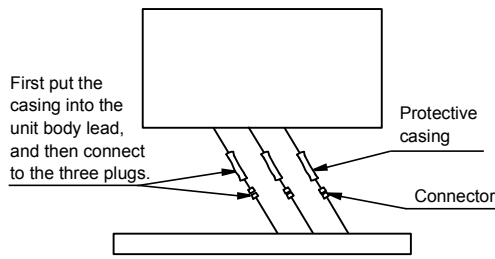

Figure 3.20

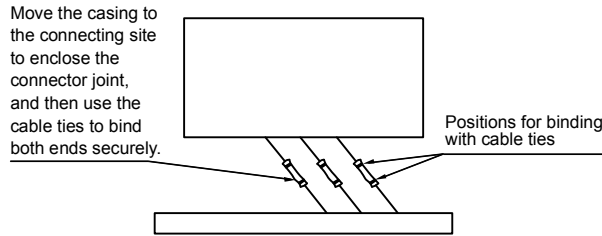

Figure 3.21

3.3.4 Reinstall the air inlet grille by performing the steps used to remove the air inlet grille in the reverse order.

4. Refrigerant Piping Installation

4.1 Length and Level Difference Requirements for the Piping Connections to the Indoor and Outdoor Units

The length and level difference requirements for the refrigerant piping are different for different indoor and outdoor units. Refer to the installation manual of the outdoor unit.

4.2 Piping Material and Size

1. Piping material: Copper pipes for air handling.
2. Piping size: Choose and purchase copper pipes that correspond to the length and size calculated for the selected model in the installation manual of the outdoor unit and your actual project requirements.

4.3 Piping Layout

1. Seal the two ends of the piping properly before you connect the indoor and outdoor piping. Once unsealed, connect the piping of the indoor and outdoor units as quickly as possible to prevent dust or other debris from entering the piping system via the unsealed ends, as this may cause the system to malfunction.
2. If the piping needs to go through walls, drill the opening in the wall, and place accessories like casings and covers for the opening properly.
3. Place the refrigerant connecting piping and the communication wiring for the indoor and outdoor units together, and bundle them tightly to make sure air does not enter and condensate to form water that may leak from the system.
4. Insert the bundled piping and wiring from outside the room through the wall opening into the room. Be careful when you lay out the piping. Do not damage the piping.

4.4 Piping Installation

- Refer to the installation manual attached with the outdoor unit on installation of the refrigerant piping for the outdoor unit.
- All gas and liquid piping must be properly insulated; otherwise, this may cause water to leak. Use heat insulation materials that can withstand high temperatures above 120°C to insulate the gas pipes. In addition, the insulation of the refrigerant piping should be reinforced (20 mm or thicker) in situations where there is high temperature and/or high humidity (when part of refrigerant piping part is higher than 30°C or when the humidity exceeds RH80%). Otherwise, the surface of the heat insulation material may be exposed.
- Before the works are carried out, verify that the refrigerant is R410A. If the wrong refrigerant is used, the unit may malfunction.
- Other than the specified refrigerant, do not let air or other gases enter the refrigeration circuit.
- If the refrigerant leaks during installation, make sure you fully ventilate the room.
- Use two wrenches when you install or dismantle the piping, a common wrench and a torque wrench. See Figure 4.1.

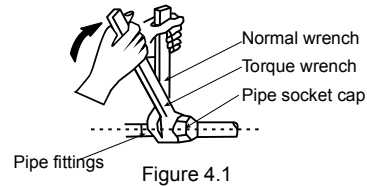

Figure 4.1

- Slot the refrigerant piping into the brass nut (accessory 11), and expand the pipe socket. Refer to the following table for the size of the pipe socket and the appropriate tightening torque.

External diameter (mm)	Tightening torque	Flared opening diameter (A)	Flared opening
Φ6.35	14.2-17.2N·m	8.3-8.7mm	<p>Figure 4.2</p>
Φ9.53	32.7-39.9N·m	12-12.4mm	
Φ12.7	49.5-60.3N·m	15.4-15.8mm	
Φ15.9	61.8-75.4N·m	18.6-19mm	
Φ19.1	97.2-118.6N·m	22.9-23.3mm	

⚠ Caution

- Apply the appropriate tightening torque according to the installation conditions. Excessive torque will damage the socket cap, and the cap will not be tight if you apply insufficient torque, leading to leakages.

- Before the socket cap is installed on the pipe socket, apply some refrigerant oil on the socket (both inside and outside), and then rotate it three or four times before you tighten the cap. See Figure 4.3.

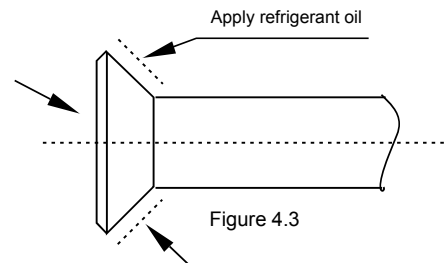

Figure 4.3

⚠ Precautions to take when welding the refrigerant pipes

- Before you weld the refrigerant pipes, fill the pipes with nitrogen first to discharge the air in the pipes. If no nitrogen is filled during welding, a large amount of oxide film will form inside the piping which may cause the air conditioning system to malfunction.
- Welding can be carried out on the refrigerant pipes when the nitrogen gas has been replaced or refilled.
- When the pipe is filled with nitrogen during welding, the nitrogen must be reduced to 0.02 MPa using the pressure release valve. See Figure 4.4.

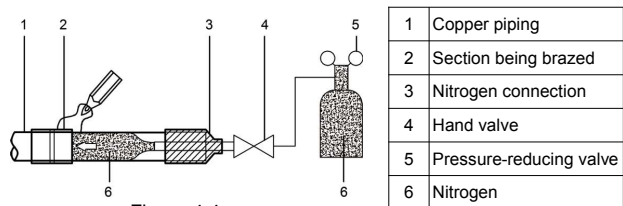

Figure 4.4

4.5 Air Tightness Test

Carry out the air tightness test on the system according to the instructions in the installation manual of the outdoor unit.

⚠ Caution

- The Air Tightness Test helps to ensure that the air and liquid cut-off valves of the outdoor unit are all closed (maintain the factory defaults).

4.6 Heat Insulation Treatment for Gas-Liquid Piping Connections for the Indoor Unit

- The heat insulation treatment is carried out on the piping at the gas and liquid sides of the indoor unit respectively.
 - a. The piping on the gas side must use heat insulation material that can withstand temperatures of 120°C and more.
 - b. For the piping connections of the indoor unit, use the insulation casing for copper pipes (accessory 6) to carry out the insulation treatment, and close all gaps.

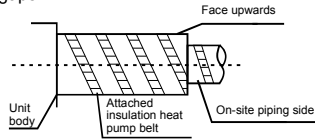

Figure 4.5

4.7 Vacuum

Create a vacuum in the system according to the instructions in the installation manual of the outdoor unit.

⚠ Caution

- For the vacuum, make sure that the air and liquid cut-off valves of the outdoor unit are all closed (maintain the factory status).

4.8 Refrigerant

Charge the system with refrigerant according to the instructions in the installation manual of the outdoor unit.

5. Water Discharge Piping Installation

5.1. Water Discharge Piping Installation for Indoor Unit

1. Use PVC pipes for the water discharge pipes (outer diameter: 30~32 mm, inner diameter: 25 mm). Based on the actual installation circumstance, users can purchase the appropriate piping length from sales agent or local after-sales service centre, or purchase directly from the local market.
2. Insert the water discharge pipe into the end of the water suction connecting pipe of the unit body, and use the ring clamp (accessory 8) to clamp the water discharge pipes with the insulation casing for the water outlet piping securely.
3. Use the insulation casing for water discharge piping (accessory 7) to bundle the water suction and discharge pipes of the indoor unit (especially the indoor portion), and use the tie for the water discharge piping (accessory 9) to bind them firmly to make sure air does not enter and condense.
4. In order to prevent the back-flow of water into the interior of the air conditioner when the operation stops, the water discharge pipe should slope downwards towards the outside (drainage side) at a slope of more than 1/100. Make sure that the water discharge pipe does not swell or store water; otherwise, it will cause strange noises. See Figure 5.1.
5. When connecting the water discharge piping, do not use force to pull the pipes to prevent the water suction pipe connections from coming loose. At the same time, set a supporting point at every 0.8~1 m to prevent the water discharge pipes from bending. See Figure 5.1.

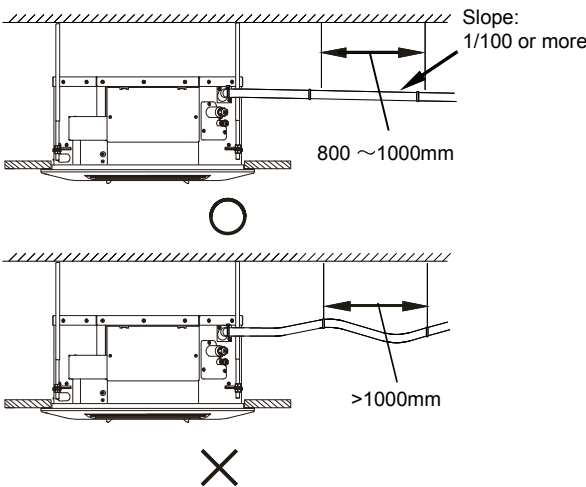

Figure 5.1

6. When connecting to a long water discharge pipe, the connections must be covered with the insulation casing to prevent the long pipe from coming loose.
7. When the outlet of the water discharge pipe is higher than the pipe connection for water suction, try to keep the water discharge pipe as vertical as possible, and the water outlet connecting fittings will bend so

that the height of the water discharge pipe should be within 600 mm away from the base of the drain pan. Otherwise, there will be excessive water flow when the operation stops. See Figure 5.2.

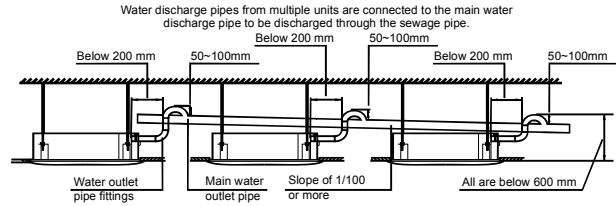

Figure 5.2

8. The end of the water discharge pipe must be more than 50 mm above the ground or from the base of the water discharge slot. Besides, do not put it in the water.

⚠ Caution

- Make sure all the connections in the piping system are properly sealed to prevent water leakages.

5.2 Water Discharge Test

- Before the test, make sure that the water discharge pipeline is smooth, and check that each connection is sealed properly.
 - Conduct the water discharge test in the new room before the ceiling is paved.
1. Remove the test water cap to connect to the test water outlet, and use the water injection pipe to inject 2000 ml of water into the drain pan.
 2. Connect the power supply, and set the air conditioner to operate in the cool mode. Check the running sound of the drainage pump, as well as whether water is properly drained from the drainage outlet.
 3. Stop the air conditioner. Wait for three minutes, and then check if there is anything unusual. If the water discharge piping layout is not correct, the excessive water flow will cause the water level error and "EE" error code will be displayed on the display panel. There may even be water overflowing from the drain pan.
 4. Continue to add water until the alarm for excessive water levels is triggered. Check if the drainage pump drains water immediately. After three minutes, if the water level does not fall below the warning level, the unit will shut down. At this time, you need to turn off the power supply, and drain away the accumulated water before you can turn on the unit normally.
 5. Turn off the power supply, remove the water manually using the drainage plug, and put the test cap back to the original place.

⚠ Caution

- The drainage plug at the bottom of the unit body is used to discharge accumulated water from the drain pan when the air conditioner malfunctions. When the air conditioner is operating normally, make sure the drainage plug is properly plugged to prevent water from leaking.

6 Electrical Wiring

⚠ Warning

- All the supplied parts, materials and electrical works must comply with local regulations.
- Use only copper wires.
- Use a dedicated power supply for the air-conditioners. The power voltage must be in line with the rated voltage.
- The electrical wiring works must be carried out by a professional technician, and must comply with the labels stated in the circuit diagram.
- Before the electrical connection works are carried out, turn off the power supply to prevent injuries caused by electric shock.
- The external power supply circuit of the air conditioner must include an earth line, and the earth line of the power cord connecting to the indoor unit must be securely connected to the earth line of the external power supply.
- Leakage protective devices must be configured according to the local technical standards and requirements for electrical and electronic devices.
- The fixed wiring connected must be equipped with an all-pole disconnection device with a minimum 3 mm contact separation.
- The distance between the power cord and signalling line must be at least 300 mm to prevent the occurrences of electrical interference, malfunction or damage to electrical components. At the same time, these line must not come in contact with the piping and valves.

- Choose electrical wiring that conforms to the corresponding electrical requirements.
- Connect to the power supply only after all the wiring and connection works have been completed, and carefully checked to be correct.

6.1 Power Cord Connection

- Use a dedicated power supply for the indoor unit that is different from the power supply for the outdoor unit.
- Use the same power supply, circuit breaker and leakage protective device for the indoor units connected to the same outdoor unit.

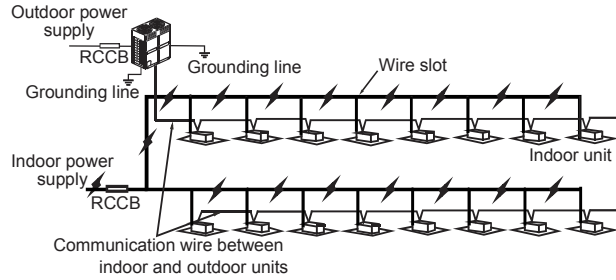

Figure 6.1

Figure 6.2 shows the power supply terminal of the indoor unit.

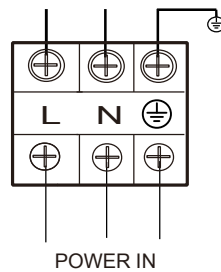

Figure 6.2

When connecting to the power supply terminal, use the circular wiring terminal with the insulation casing (see Figure 6.3).

Use power cord that conforms to the specifications and connect the power cord firmly. To prevent the cord from being pulled out by external force, make sure it is fixed securely.

If circular wiring terminal with the insulation casing cannot be used, please make sure that:

- Do not connect two power cords with different diameters to the same power supply terminal (may cause overheating of wires due to loose wiring) (See Figure 6.4).

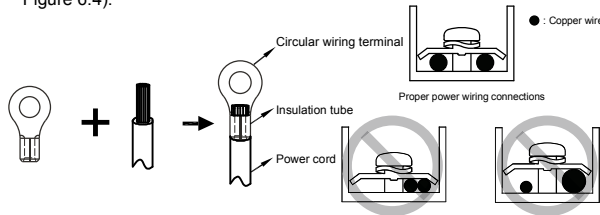

Figure 6.3

Figure 6.4

6.2 Electrical Wiring Specifications

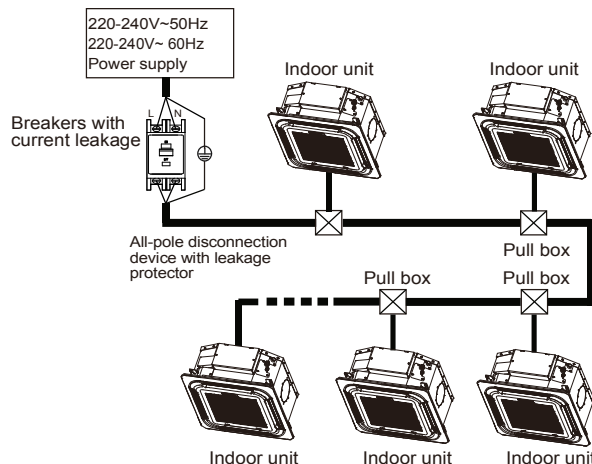

Figure 6.5

Refer to Tables 6.1 and 6.2 for the specifications of the power cord and communication wire. A wiring capacity that is too small will cause the electrical wiring to become too hot, and lead to accidents when the unit burns and becomes damaged.

Table 6.1

Model	05-15	
Power supply	Phase	1-phase
	Volt and frequency	220-240V~50Hz 220-240V~60Hz
Communication wire between indoor and outdoor units		Shielded 3×AWG16-AWG18
Communication wire between indoor unit and wired controller *		Shielded AWG16-AWG20
Field fuses		15A

* Please refer to the corresponding wired controller manual for the wired controller wiring.

Table 6.2 Indoor units electrical characteristics

Capacity	Power supply				IFM	
	Hz	Volts	MCA	MFA	kW	FLA
05	50	220-240	0.2	15	0.05	0.16
07			0.2	15	0.05	0.16
09			0.2	15	0.05	0.16
12			0.3	15	0.056	0.24
15			0.3	15	0.056	0.24

Capacity	Power supply				IFM	
	Hz	Volts	MCA	MFA	kW	FLA
07	60	220-240	0.2	15	0.05	0.16
09			0.2	15	0.05	0.16
12			0.2	15	0.06	0.16
15			0.2	15	0.06	0.16

Abbreviations:

MCA: Minimum Circuit Amps kW: Rated motor output FLA: Full Load Amps
MFA: Maximum Fuse Amps IFM: Indoor Fan Motor

1. Select the wire diameters(minimum value) individually for each unit based on the table 6.3.
2. Maximum allowable voltage range variation between phases is 2%.
3. Select circuit breaker that having a contact separation in all poles not less than 3 mm providing full disconnection, where MFA is used to select the current circuit breakers and residual current operation breakers:

Table 6.3

Rated current of appliance (A)	Nominal cross-sectional area (mm ²)	
	Flexible cords	Cable for fixed wiring
≤3	0.5 and 0.75	1 to 2.5
>3 and ≤6	0.75 and 1	1 to 2.5
>6 and ≤10	1 and 1.5	1 to 2.5
>10 and ≤16	1.5 and 2.5	1.5 to 4
>16 and ≤25	2.5 and 4	2.5 to 6
>25 and ≤32	4 and 6	4 to 10
>32 and ≤50	6 and 10	6 to 16
>50 and ≤63	10 and 16	10 to 25

Warning

Refer to local laws and regulations when deciding on the dimensions for the power cords and wiring. Get a professional to select and install the wiring.

6.3 Communication Wiring

- Use only shielded wires for the communication wiring. Any other type of wires may produce a signal interference that will cause the units to malfunction.
- Do not carry out electrical works like welding with the power on.
- Do not bind the refrigerant piping, power cords and communication wiring together. When the power cord and communication wiring are parallel, the distance between the two lines must be 300 mm or more in order to prevent signal source interference.
- Communication wiring must not form a closed loop.

6.3.1 Communication wiring between the indoor and outdoor units

- The indoor and outdoor units communicate via the RS485 serial port.

- The communication wiring between the indoor and outdoor units should connect one unit after another in a daisy chain from the outdoor unit to the final indoor unit, and the shielded layer must be properly grounded, and a build-out resistor must be added to the last indoor unit to enhance the stability of the communication system (see Figure 6.6).
- Incorrect wiring such as a star connection or a closed ring will cause instability of the communication system and system control anomalies.
- Use a three core shielded wire (greater than or equal to 0.75 mm²) for the communication wiring between the indoor and outdoor units. Make sure the wiring is connected correctly. The connecting lead for this communication wire must come from the master outdoor unit.
- All shielded wiring in the network are interconnected, and will eventually connect to earth at the same point "⊕".

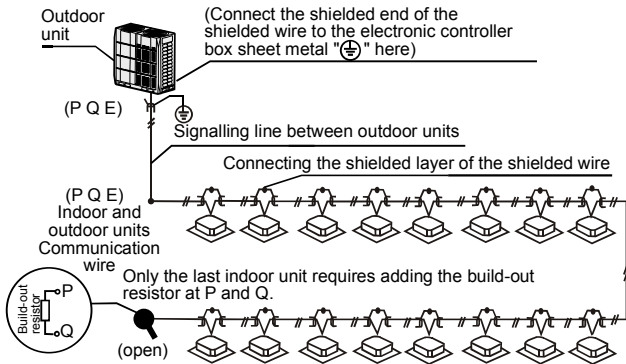

Figure 6.6

6.3.2 Communication wiring between the indoor unit and wired controller

The wired controller and the indoor unit can be connected in different manners, depending on the forms of communication.

1) For a bidirectional communication mode:

- Use 1 wired controller to control 1 indoor unit or 2 wired controllers (one master and one slave controller) to control 1 indoor unit (see Figure 6.7);
- Use 1 wired controller to control multiple indoor units or 2 wired controllers (one master and one slave controller) to control multiple indoor units (see Figure 6.8);

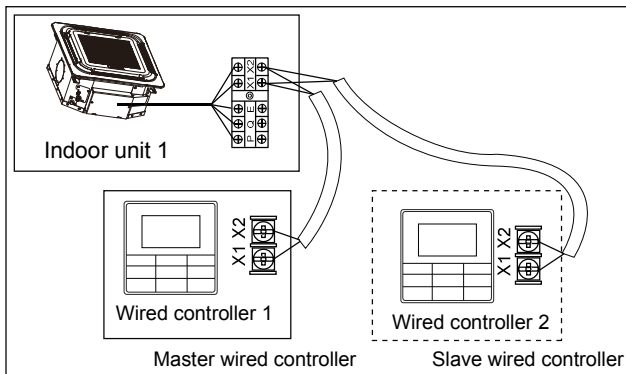

Figure 6.7

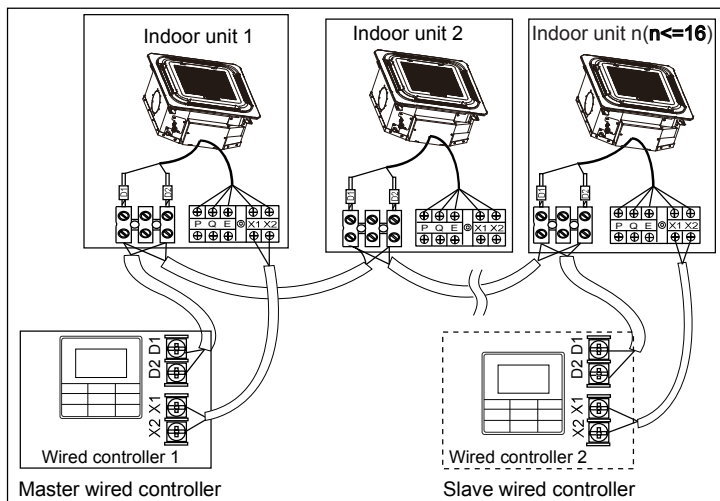

Figure 6.8

2) For a unidirectional communication mode:

- Use 1 wired controller to control 1 indoor unit (see Figure 6.9).

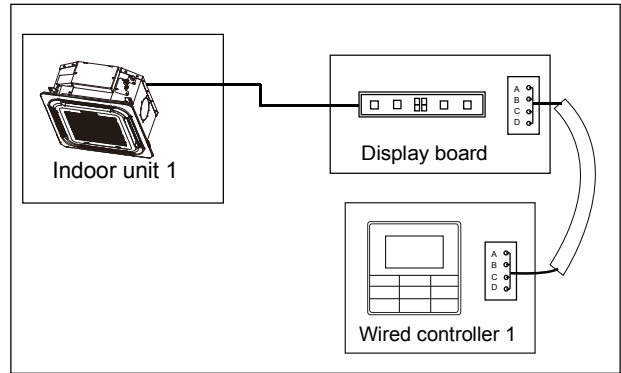

Figure 6.9

- For the specific connection method, refer to the instructions in the corresponding wired controller manual to carry out the wiring and connections.
- The X1/X2, D1/D2 ports on the sides of the main control board and the unidirectional communication port (display board side) are for different types of wired controllers (see Figure 6.10).
- Use the connecting wires (from the accessories) to connect the D1/D2 terminals.

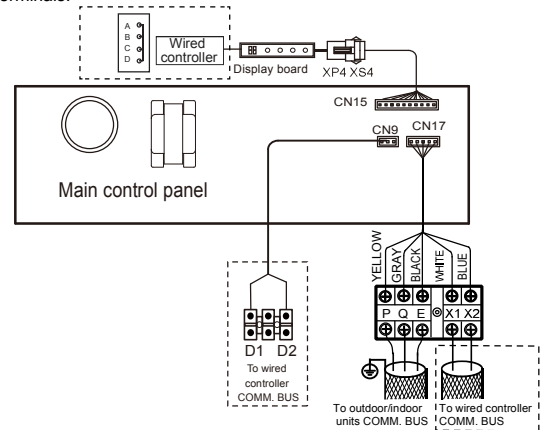

Figure 6.10

6.4 Handling the Electrical Wiring Connection Points

- Once the wiring and connections are done, use tie straps to secure the wiring properly so that the connection joint cannot be pulled apart by external force. The connection wiring must be straight out so that the cover of the electrical box is level and can be closed tightly.
- Use professional insulation and sealing materials to seal and protect the perforated wires. Poor sealing may lead to condensation, and entry of small animals and insects that may cause short circuits in parts of the electrical system, causing the system to fail.

6.5 Panel Wiring

Refer to the panel installation instructions in 3.3.4 to connect the terminals of the display board and the swing motor.

7. On-site Configuration

7.1 Capacity Settings

Set up the PCB DIP switch on the indoor electric control box to cater to different uses. Once the settings are done, make sure you cut off the main power switch again, and then switch the power on. If the power is not cut off and switched on again, the settings will not be executed.

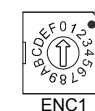

ENC1 Settings for Capacity DIP Switch:

DIP Switch Code	Capacity(kBtu/h)
1	05
2	07
3	09
4	12
6	15

⚠ Caution

- The capacity DIP switches have been configured before delivery. Only a professional maintenance personnel should change these settings.

7.2 Address Settings

When this indoor unit is connected to the outdoor unit, the outdoor unit will automatically allocate the address to the indoor unit. Alternatively, you may use the controller to manually set the address.

- The addresses of any two indoor units in the same system cannot be the same.
- The network address and the indoor unit address are the same, and does not have to be configured separately.
- Once the address settings are completed, mark the address of each indoor unit to facilitate after-sales maintenance.
- The centralized control of the indoor unit is completed on the outdoor unit. For details, refer to the manual on the outdoor unit.

⚠ Caution





- Once the centralized control function for the indoor unit has been completed on the outdoor unit, the DIP switch on main control panel of the outdoor unit must be set to auto addressing; otherwise, the indoor unit in the system are not controlled by the centralized controller.



⚠ Caution

- The system can connect up to 64 indoor units (address 0~63) at the same time. Each indoor unit can only have one address DIP switch in the system. The addresses of any two indoor units in the same system cannot be the same. Units that have the same address may malfunction.



7.3 DIP Switch Settings on Main Board



0/1 definition of each dial code switch:	
	means 0
	means 1

SW8 definition (function reserved)	
SW8 [00] 	Alarm port is used to output alarm signal
SW8 [01] 	Alarm port is used as fresh air port
SW8 [10] 	Alarm port is used as running output of indoor units
SW8 [11] 	Alarm port is used to output alarm signal

SW9_1 definition (function reserved)	
SW9 [0] 	Unit is forced to shut down when remote switch is ON
SW9 [1] 	Unit is forced to shut down when remote switch is OFF

SW9_2: reserved

J1 definition	
J1 	Auto restart function enabled
J1 	Auto restart function disabled

J2 definition	
J2 	CN20 network module enabled (external network module is needed), and the infrared function of display board disabled
J2 	CN20 network module disabled, and the infrared function of display board enabled

⚠ Note

- All DIP switches (including the capacity DIP switch) have been configured before delivery. Only a professional maintenance personnel should change these settings.
- Improper DIP switch settings may cause condensation, noise, or unexpected system malfunction.

7.4 Error Codes and Definitions

Error code	Error Content
FE	The indoor unit has not been assigned an address
E0	Mode conflict error
E1	Communication error with outdoor unit
E2	T1(Indoor ambient) temperature sensor error
E3	T2(Indoor heat exchanger mid-point) temperature sensor error
E4	T2B(Indoor heat exchanger outlet) temperature sensor error
E7	EEPROM error
E9	Communication error with wired controller
Ed	Outdoor unit error
Eb	Indoor EXV coil error
H4	Communication error between indoor unit and adapter board or panel
H5	EEPROM error(adapter board or panel)
HA	Smart Eye error
F7	Repeated indoor unit address (F7+repeated address)
F8	MS error
U4	MS self-check error
A1	Refrigerant leakage error
A0	Emergency stop
EE	Water level error
FA	Capacity(HP) has not been set

8. Test Run

8.1 Things to Note Before Test Run

- ◆ Indoor and outdoor units are properly installed;
- ◆ Piping and wiring are correct;
- ◆ No leakage from the refrigerant piping system;
- ◆ Water discharge is smooth;
- ◆ Insulation is complete;
- ◆ Grounding line has been properly connected;
- ◆ Piping length, and amount of refrigerant filled have been recorded;
- ◆ The voltage of the power supply is the same as the rated voltage of the air conditioner;
- ◆ No obstacles at the air inlet and outlet of the indoor and outdoor units;
- ◆ Cut-off valves for the gas and liquid ends of the outdoor unit are opened;

8.2. Test Run

When the wired/remote controller is used to set the cooling operations of the air conditioner, check the following items one by one. If there is a fault, troubleshoot according to the manual.

- ◆ Function keys of the wired/remote controller are operating normally;
- ◆ Room temperature regulation is normal;
- ◆ LED indicator is on;
- ◆ Water discharge is normal;
- ◆ No vibration and strange sounds during operation;

Note: Once the power is connected, when the unit is turned on or started immediately after the unit is turned off, the air conditioner has a protective function which delays the start of the compressor.

Operation manual

There are two types of precautions as described below:

 Warning: Failure to comply may lead to death or serious injury.

 Caution: Failure to comply may lead to injury or damage of the unit. Depending on the situation, this may also lead to serious injury.

Once the installation is completed, please keep the manual properly for future reference. When this air conditioner is handed over to other users, make sure that the manual is included with the handover.

Warning

- Do not use this unit in locations where flammable gas may exist. If flammable gas comes into contact with the unit, a fire may occur, which could result in serious injury or death.
- If this unit exhibits any abnormal behavior (such as emitting smoke) there is a danger of serious injury. Disconnect the power supply and contact your supplier or service engineer immediately.
- The refrigerant in this unit is safe and should not leak if the system is designed and installed properly. However, if a large amount of refrigerant leaks into a room, the oxygen concentration will decrease rapidly, which can cause serious injury or death. The refrigerant used in this unit is heavier than air, so the danger is greater in basements or other underground spaces. In the event of a refrigerant leak, turn off any devices that produce a naked flame and any heating devices, ventilate the room, and contact your supplier or service engineer immediately.
- Toxic fumes may be produced if the refrigerant in this unit comes into contact with naked flames (such as from a heater, gas stove/burners, or electric appliances).
- If this unit is used in the same room as a cooker, stove, hob, or burner, ventilation for sufficient fresh air must be ensured, otherwise the oxygen concentration will fall, which may cause injury.
- Dispose of this unit's packaging carefully, so children cannot play with it. Packaging, especially plastic packaging, can be dangerous, can cause serious injury or death. Screws, staples and other metal packaging components can be sharp and should

be disposed of carefully to avoid injury.

- Do not attempt to inspect or repair this unit yourself. This unit should only be serviced and maintained by a professional air conditioning service engineer. Incorrect servicing or maintenance can cause electric shocks, fire or water leaks.
- This unit should only be re-positioned or re-installed by a professional technician. Incorrect installation can lead to electric shocks, fire or water leaks. The installation and grounding of electrical appliances should only be carried out by licensed professionals. Ask your supplier or installation engineer for further information.
- Do not allow this unit or its remote controller to come into contact with water, as this can lead to electric shocks or fire.
- Turn off the unit before cleaning it to avoid electric shocks. Otherwise, an electric shock and injury may result.
- To avoid electric shocks and fires, install an earth leakage detector.
- Do not use paint, varnish, hair spray, other flammable sprays or other liquids that may give off flammable fumes/vapor near this unit, as doing so can cause fires.
- When replacing a fuse, ensure that the new fuse to be installed completely complies with requirements.
- Do not open or remove the unit's panel when the unit is powered on. Touching the unit's internal components while the unit is powered on can lead to electric shocks or injuries caused by moving parts such as the unit's fan.
- Ensure that the power supply is disconnected before any servicing or maintenance is carried out.
- Do not touch the unit or its remote controller with wet hands, as doing so can lead to electric shocks.
- Do not allow children to play near this unit, as doing so risks injury.
- Do not insert your fingers or other objects into the unit's air inlet or air outlet to avoid injury or damage to the equipment.
- Do not spray any liquids onto the unit or allow any liquids to drip onto the unit.
- Do not place vases or other liquid containers on the unit or in places where liquid could drip onto it. Water or other liquids that come into contact with the unit can lead to electric shocks or fires.
- Do not remove the remote controller's front or back covers and do not touch the remote controller's internal components, as doing so can cause injury. If the remote controller stops working, contact your supplier or service engineer.
- Ensure that the unit is properly grounded, otherwise electric shocks or a fire may result. Electrical surges (such as those that can be caused by lightning) can damage electrical equipment. Ensure that suitable surge protectors and circuit breakers are properly installed, otherwise electric shocks or a fire may result.
- Dispose of this unit properly and in accordance with regulations. If electrical appliances are disposed of in landfills or dumps, hazardous substances can leak into the groundwater and thus enter the food chain.
- Do not use the unit until the qualified technician instructs you that it is safe to do so.
- Do not place appliances that produce naked flames in the path of the airflow from the unit. The airflow from the unit may increase the rate of combustion, which may cause a fire and cause serious injury or death. Alternatively, the airflow may cause incomplete combustion which can lead to reduced oxygen concentration in the room, which can cause serious injury or death.

⚠ Caution

- Only use the air conditioner for its intended purpose. This unit should not be used to provide refrigeration or cooling for food, plants, animals, machinery, equipment or art.
- Do not insert your fingers or other objects into the unit's air inlet or air outlet to avoid injury or damage to the equipment.
- The fins on the unit's heat exchanger are sharp and can cause injury if touched. To prevent injury, when the unit is being serviced, gloves should be worn or the heat exchanger should be covered.
- Do not place items which might be damaged by moisture under the unit. When the humidity is greater than 80% or if the drain pipe is blocked or the air filter is dirty, water could drip from the unit and damage objects placed under the unit.
- Ensure that the drain pipe functions properly. If the drain pipe is blocked by dirt or dust, water leaks may occur when the unit is running in cooling mode. If this happens, turn the unit off and contact your supplier or service engineer.
- Do not touch the internal parts of the controller. Do not remove the front panel. Some internal parts may cause injury or be damaged.
- Ensure that children, plants and animals are not directly exposed to the airflow from the unit.
- When fumigating a room with insecticide or other chemicals, cover the unit well and do not run it. Failure to observe this caution could lead to chemicals getting deposited inside the unit and later emitted from the unit when it running, endangering the health of any room occupants.
- Do not dispose of this product as unsorted waste. It must be separately collected and processed. Ensure that all applicable legislation regarding the disposal of refrigerant, oil and other materials is adhered to. Contact your local waste disposal authority for information about disposal procedures.
- To avoid damaging the remote controller, exercise caution when using it and replacing its batteries. Do not place objects on top of it.
- Do not place appliances that have naked flames under or near the unit, as heat from the appliance can damage the unit.
- Do not place the unit's remote controller in direct sunlight. Direct sunlight can damage the remote controller's display.
- Do not use strong chemical cleaners to clean the unit, as doing so can damage the unit's display or other surfaces. If the unit is dirty or dusty, use a slightly damp cloth with very diluted and mild detergent to wipe the unit. Then, dry it with a dry cloth.
- Children shall not play with the appliance.

- Do not dispose of this product as unsorted waste. It must be separately collected and processed. Ensure that all applicable legislation regarding the disposal of refrigerant, oil and other materials is adhered to. Contact your local waste disposal authority for information about disposal procedures.



- This appliance is not intended for use by persons (including children) with reduced physical, sensory or mental capabilities, or lack of experience and knowledge, unless they have been given supervision or instruction concerning use of the appliance by a person responsible for their safety. Children should be supervised to ensure that they do not play with the appliance.
- This appliance can be used by children aged from 8 years and above and persons with reduced physical, sensory or mental capabilities or lack of experience and knowledge if they have been given supervision or instruction concerning use of the appliance in a safe way and understand the hazards involved. Children shall not play with the appliance. Cleaning and user maintenance shall not be made by children without supervision.

9. Part Names

The figure shown above is for reference only and may be slightly different from the actual product.

Air Outlet Louver (adjustable)

For in-situ adjustment to three-direction or two-direction, please contact the local dealer.

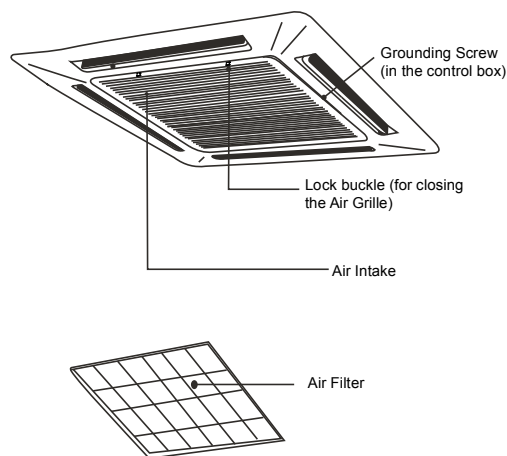

Figure 9.1

10. The Explain Of The Display Panel

The display panel is shown in Figure 10.1 .

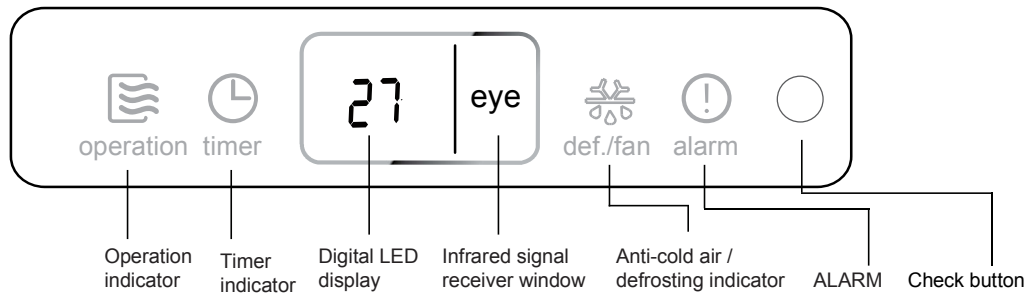

Figure 10.1

Table: Display panel output under normal operating conditions.

Unit state		Display output	
		Digital display panels	
		Unit state	Digital display
Standby		Operation indicator flashes slowly	
Shutting-down		All indicators off	
Operation	Normal operation	Operation indicator on	Cooling and heating modes: set temperature Fan only mode: indoor ambient temperature
	Cold draft prevention or outdoor unit defrosting operation	Operation and Anti-cold / defrosting indicators on	Set temperature
A timer has been set		Timer indicator on	

11. Air Conditioner Operations and Performance

The operating temperature range under which the unit runs stably are given in below table.

	Cooling mode	Heating mode
Indoor temperature	17 ~ 32°C(DB)	15 ~ 27°C(DB)
Indoor humidity	≤80% ^(a)	

(a) Condensation will form on the unit surface and water dripping out of the unit when the indoor humidity is beyond 80%

⚠ Caution

- The unit performs stably in the temperature range given in above table. If the indoor temperature is outside the unit's normal operating range, it may stop running and display an error code.

To ensure the desired temperature is achieved efficiently, ensure that:

- All windows and door are closed.
- The airflow direction is adjusted to work in running mode.
- The air filter is clean.

Please note how you can best save energy and achieve the best cooling/heating effect.

- Regularly clean air filters inside indoor units

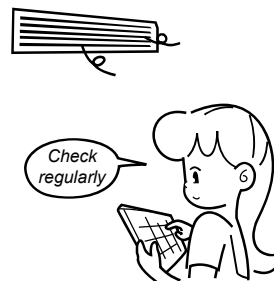

Figure 11.1

- ◆ Avoid too much outdoor air coming into air-conditioned spaces.



Figure 11.2

- ◆ Note that outlet air is cooler or heater than set room temperature. Avoid direct exposure to outlet air as it may be too cool or hot.

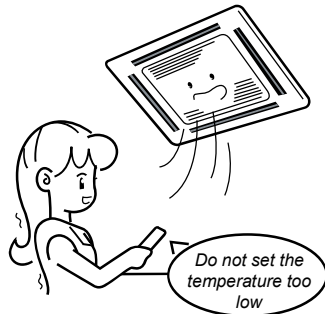

Figure 11.3

- ◆ Maintain a proper air distribution. Air outlet louvers should be used to adjust the direction of outlet airflow, as doing so might ensure more efficient operation.



Figure 11.4

12. Adjusting Air Flow Direction

Since warmer air rises and cooler air falls, the distribution of warmed/cooled air around a room can be improved by positioning the unit's louvers. The louver angle can be adjusted by pressing the [SWING] button on the remote controller.

⚠ Caution

- During heating operation, horizontal airflow will aggravate the uneven distribution of room temperature.
- The louver direction: horizontal airflow is recommended during cooling operation. Note the downward air flow will cause condensation on the air outlet and louver surface.

- ◆ Adjust the air direction up and down
 - a. Auto-swing: Press SWING for the louver to swing up and down.
 - b. Manual swing: Adjust the louver to improve the cooling or heating effect.
 - c. When cooling adjust the louver horizontally.



Figure 12.1

- d. When heating adjust the louver downward.

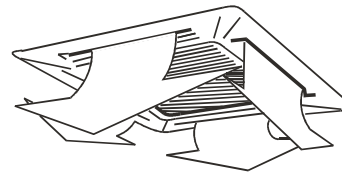

Figure 12.2

13. Maintenance

⚠ Caution

- Before you clean the air conditioner, ensure it is powered off.
- Check that the wiring is undamaged and connected.
- Use a dry cloth to wipe the indoor unit and remote controller.
- A wet cloth may be used to clean the indoor unit if it is very dirty.
- Never use a damp cloth on the remote controller.
- Do not use a chemically treated duster on the unit or leave this type of material on the unit to avoid damaging the finish.
- Do not use benzene, thinner, polishing powder, or similar solvents for cleaning. These may cause the plastic surface to crack or warp.

◆ Method for cleaning the air filter

- a. The air filter can prevent the dust or other particles from entering the unit. If the filter is blocked, the unit will not work well. Clean the filter every two weeks when you use it regularly.
 - b. If the air conditioner is positioned in a dusty place, clean the filter often.
 - c. Replace the filter if it is too dusty to clean (the replaceable air filter is an optional fitting).
1. Take out the air intake grille
- ◆ Push the grille switches simultaneously, as indicated in Fig.13.1. Then pull down the air intake grille (together with the air filter, as shown in Fig.13.2). Pull the air intake grille down to 45°, and lift it up to remove the grille.

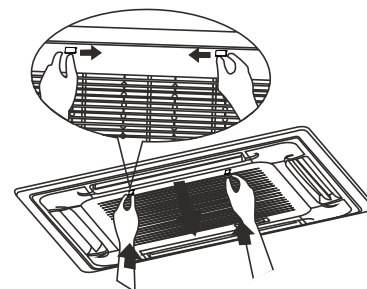

Figure 13.1

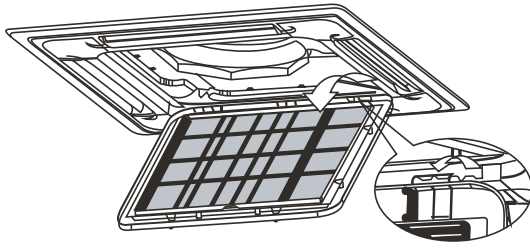

Figure 13.2

⚠ Caution

- The control box cables originally connected to the electrical terminals on the main body must be removed, as indicated above.

2. Dismantle the air filter.
3. Clean the air filter

Dusts will accumulate on the filter along with the unit operation, and need to be removed from the filter, or the unit would not function effectively.

Clean the filter every two weeks when you use the unit regularly. Clean the air filter with a vacuum cleaner or water.

- a. The air intake side should face up when using a vacuum cleaner. (Refer to Fig.13.3)
- b. The air intake side should face down when using clean water. (Refer to Fig.13.4)

For excessive dusts, use a soft brush and natural detergent to clean it and dry in a cool place.

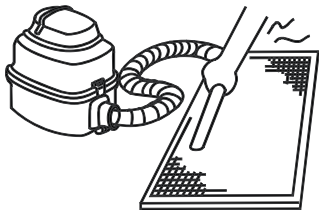

Figure 13.3

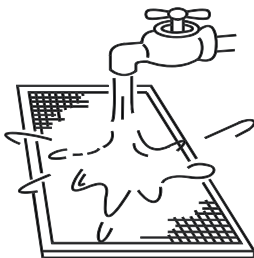

Figure 13.4

⚠ Caution

- Do not dry out the air filter under direct sunshine or with fire.
- The air filter should be installed before the unit body installation.

4. Re-install the air filter.
 5. Install and close the air inlet grille by reversing steps 1 and 2, and connect the control box cables to the corresponding terminals in the main body.
- ♦ **Maintenance before stopping using the unit for a long time (e.g., at the end of a season)**
 - a. Let the indoor units run in fan only mode for about half a day to dry the interior of the unit.

- b. Clean the air filter and indoor unit casing.
- c. Refer to "Cleaning the air filter" for details. Install cleaned air filters back in their original positions.
- d. Turn off the unit with the ON/OFF button on the remote controller, and then unplug it.

⚠ Caution

- When the power switch is connected, some energy will be consumed even if the unit is not running. Disconnect the power to save energy.
- A degree of dirt will accumulate when the unit has been used several times, which will require cleaning.
- Take of the batteries from the remote controller.

♦ **Maintenance after a long period of non-use**

- a. Check for and remove anything that might be blocking the inlet and outlet vents of the indoor units and outdoor units.
- b. Clean the unit casing and clean the filter. Refer to [Cleaning the filter] and "Cleaning the filter" for instructions. Re-install the filter before running the unit.
- c. Turn on the power at least 12 hours before you want to use the unit to ensure it works properly. As soon as the power is turned on, the remote control display appears.

14. Symptoms That Are Not Faults

The following symptoms may be experienced during the normal operation of the unit and are not considered faults. Note: If you are not sure whether a fault has occurred, contact your supplier or service engineer immediately.

Symptom 1: The unit will not run

- ♦ **Symptom:** When the ON/OFF button on the remote controller is pressed, the unit does not immediately start running.
Cause: to protect certain system components, system start-up or re-start is intentionally delayed for up to 12 minutes under some operating conditions. If the OPERATION LED on the unit's panel is lighting, the system is working normally and the unit will start after the intentional delay is complete.
- ♦ **Heating mode is running** when the following panel lights are on: operation and the "DEF./FAN LED indicator".
Cause: the indoor unit activates protective measures because of the low outlet temperature.

Symptom 2: The unit emits white mist

- ♦ White mist is generated and emitted when the unit starts to operate in a very humid environment. This phenomenon will stop once the humidity in the room is reduced to normal levels.
- ♦ The unit occasionally emits white mist when it runs in heating mode. This occurs when the system finishes periodic defrosting. Moisture that may accumulate on the unit's heat exchanger coil during defrosting becomes mist and is emitted from the unit.

Symptom 4: Dust is emitted from the unit

- ♦ This can occur when the unit first runs after a long idle period.

Symptom 5: The unit gives off a strange odor

- ♦ If smells such as those of strong-smelling food or tobacco smoke are present in the room, they can enter the unit, leave trace deposits on the unit's internal components, and later be emitted from the unit.

15. Troubleshooting

15.1 General

- ♦ Sections 15.2 and 15.3 describe some initial troubleshooting steps that can be taken when an error occurs. If these steps do not resolve the issue, arrange for a professional technician to investigate the problem. Do not attempt further investigations or troubleshooting yourself.
- ♦ If any of the following errors occur, power the unit off, contact a professional technician immediately and do not attempt troubleshooting yourself:

- A safety device such as a fuse or circuit breaker frequently blows/trips.
- An object or water enters the unit.
- Water is leaking from the unit.

Caution

- Do not attempt to inspect or repair this unit by yourself. Arrange for a qualified technician to carry out all servicing and maintenance.

15.2 Unit Troubleshooting

Symptom	Possible causes	Troubleshooting steps
The unit does not start	A power cut has occurred (the power to the premises has been cut-off).	Wait for the power to come back on.
	The unit is powered off.	Power on the unit. This indoor unit forms part of an air conditioning system that has multiple indoor units that are all connected. The indoor units cannot be powered on individually - they are all connected to one, single power switch. Ask a professional technician for advice regarding how to safely power on the units.
	The power switch fuse may have burned out.	Replace the fuse.
	The remote controller's batteries are dead.	Replace the batteries.
Air flows normally but doesn't cool	The temperature setting is not correct.	Set the desired temperature on the remote controller.
The unit starts or stops frequently	Arrange for a professional technician to check the following: <ul style="list-style-type: none"> ♦ Too much or too little refrigerant. ♦ No gas in the refrigerant circuit. ♦ The outdoor unit compressors have malfunctioned. ♦ The power supply voltage is too high or too low. ♦ There is a blockage in the piping system. 	
Low cooling effect	Doors or windows are open.	Close the doors and windows.
	Sunlight is shining directly onto the unit.	Close shutters/blinds to shield the unit from direct sunlight.
	The room contains many heat sources such as computers or refrigerators.	Turn off some of the computers during the hottest part of the day.
	The unit's air filter is dirty.	Clean the filter.
	The outside temperature is unusually high.	The cooling capacity of the system reduces as the outdoor temperature rises and the system may not provide sufficient cooling if the local climate conditions are not considered when the system's outdoor units were selected.
	Engage a professional air conditioning engineer to check the following: <ul style="list-style-type: none"> ♦ The unit's heat exchanger is dirty. ♦ The unit's air inlet or outlet is blocked. ♦ A refrigerant leak has occurred. 	
Low heating effect	Doors or windows are not completely closed.	Close doors and windows.
	Arrange for a professional technician to check the following: A refrigerant leak has occurred.	

15.3 Remote Controller Troubleshooting

Warning:

Certain troubleshooting steps that a professional technician may perform when investigating an error are described in this owner's manual for reference only. Do not attempt to undertake these steps yourself – arrange for a professional technician to investigate the problem.

If any of the following errors occur, power the unit off and contact a professional technician immediately. Do not attempt troubleshooting yourself:

- ◆ A safety device such as a fuse or circuit breaker frequently blows/trips.
- ◆ An object or water enters the unit.
- ◆ Water is leaking from the unit.

Symptom	Possible causes	Troubleshooting steps
The fan speed cannot be adjusted	Check whether the MODE indicated on the display is "AUTO".	In automatic mode, the air conditioner will automatically change the fan's speed.
	Check whether the MODE indicated on the display is "DRY".	When dry mode is selected, the air conditioner automatically adjusts the fan speed. (The fan speed can be selected during "COOL", "FAN ONLY", and "HEAT".)
The remote controller signal is not transmitted even when the ON/OFF button is pushed	A power cut has occurred (the power to the premises has been cut-off).	Wait for the power to come back on.
	The remote controller's batteries are	Replace the batteries.
The indication on the display disappears after a certain time	Check whether the timer operation has come to an end when TIMER OFF is indicated on the display.	The air conditioner operation will stop up to the set time.
The TIMER ON indicator goes off after a certain time	Check whether the timer operation has come to an end when TIMER ON is indicated on the display.	Up to the set time, the air conditioner will automatically start and the appropriate indicator will go off.
No receiving sound from the indoor unit when the ON/OFF button is pressed	Check whether the signal transmitter of the remote controller is properly directed to the infrared signal receiver of the indoor unit when the ON/OFF button is pressed.	Directly transmit the signal transmitter of the remote controller to the infrared signal receiver of the indoor unit, and then press the ON/OFF button twice.

15.4 Error Codes

With the exception of a mode conflict error, contact your supplier or service engineer if any of the error codes listed in the following table are displayed on the unit's display panel. If the mode conflict error is displayed and persists, contact your supplier or service engineer. These errors should only be investigated by a professional technician. The descriptions are provided in this manual for reference only.

Content	Display output	Possible causes
Mode conflict	E0	<ul style="list-style-type: none"> ♦ The indoor unit's operating mode conflicts with that of the outdoor units.
Communication error with outdoor unit	E1	<ul style="list-style-type: none"> ♦ Communication wires between indoor and outdoor units not connected properly. ♦ Interference from high voltage wires or other sources of electromagnetic radiation. ♦ Communication wire too long. ♦ Damaged main PCB.
T1(Room temperature sensor) malfunction	E2	<ul style="list-style-type: none"> ♦ Temperature sensor not connected properly or has malfunctioned. ♦ Damaged main PCB.
T2(Middle of evaporator temperature sensor) malfunction	E3	
T2B (Outlet of evaporator temperature sensor) malfunction	E4	
EEPROM error	E7	<ul style="list-style-type: none"> ♦ Damaged main PCB.
Communication Error with wired controller (only displayed on wired controller)	E9	<ul style="list-style-type: none"> ♦ Communication wire loosened or broken. ♦ The wired controller is out of order. ♦ Damaged main PCB.
Indoor EXV coil error	Eb	<ul style="list-style-type: none"> ♦ Line loosened or broken. ♦ The electronic expansion valve is stuck. ♦ Damaged main PCB.
Outdoor unit error	Ed	<ul style="list-style-type: none"> ♦ Outdoor unit error.
Water level error	EE	<ul style="list-style-type: none"> ♦ Water level float stuck. ♦ Water level switch not connected properly. ♦ Damaged main PCB. ♦ Drain pump has malfunctioned.
The indoor unit has not been assigned an address	FE	<ul style="list-style-type: none"> ♦ Indoor unit has not been assigned an address.
Repeated indoor unit address (F7+repeated address)	F7	<ul style="list-style-type: none"> ♦ Same address set on different units.
MS error	F8	<ul style="list-style-type: none"> ♦ MS error.
MS self-check error	U4	<ul style="list-style-type: none"> ♦ MS self-check fails.
Refrigerant leakage error	A1	<ul style="list-style-type: none"> ♦ Refrigerant leakage occurs.
Capacity(HP) has not been set	FA	<ul style="list-style-type: none"> ♦ The capacity of the indoor unit has not been set.

Notes:

Flashing rapidly means flashing twice per second; flashing slowly means flashing once per second.



OMEGA
ENVIRONMENTAL
TECHNOLOGIES LLC.

17702 Mitchell North, #101
Irvine, CA. 92614 .USA
Tel: 714 795 2830
Fax: 714 966 1646
info@omegainverter.com
www.omegainverter.com

OTECTM
AIR CONDITIONING

Showroom & Technology Center
11380 Interchange Circle North
Miramar, FL 33025 .USA
Tel: 305 901 1270
Fax: 954 212 8280
info@otecomega.com
www.otecomega.com

BECMQ3A-IM1D1222